

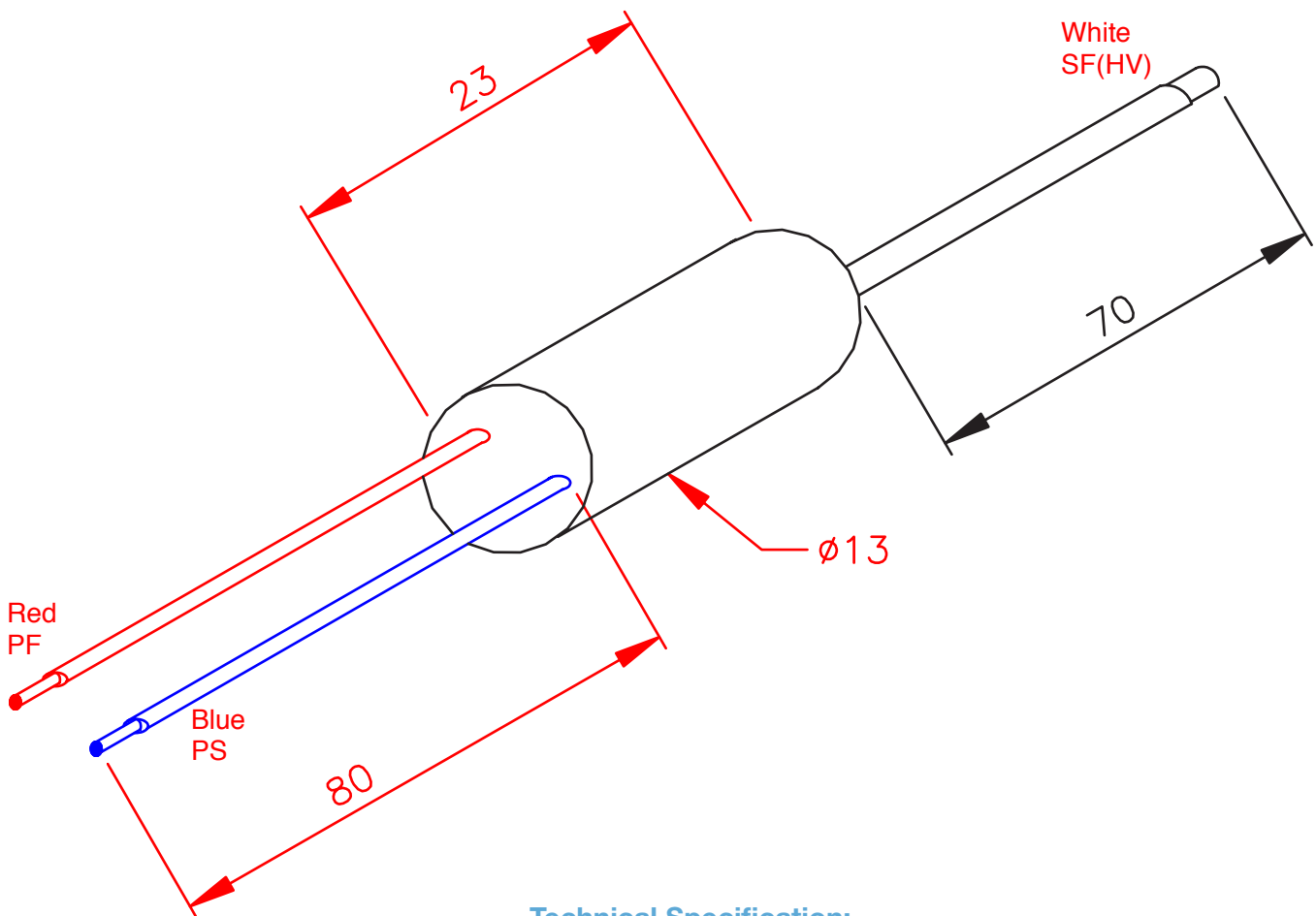

FTR20-5 External Trigger Transformer



Technical Specification:

Maximum Input Voltage:	400V
Output Voltage:	20KV
Turns Ratio:	60:1
Primary Inductance:	35±5µH
Max Input Energy	20mJ

First Light Lamps Ltd

Unit 9, Lancaster Way Business Park, Ely, Cambridgeshire, CB6 3NW, UK

Tel: +44 (0)1353 659922 Fax: +44 (0)1353 668883

Email: info@firstlightlamps.com

www.firstlightlamps.com

FIRSTLIGHT